



ELECTRIC MOTORCYCLE

OWNER'S MANUAL

Important Information! Read thoroughly before driving the first time.

All information, images, and specifications contained in this manual are based on the latest product information available at the time of publication. Due to improvements or production changes, there could be discrepancies in this manual. We reserve the right to make product changes at any time, without notice and without obligation to make the same or similar changes to any vehicle previously built or sold.



ELECTRIC MINI MOTORCYCLE OWNER'S MANUAL

INTRODUCTION



Thank you for purchasing this product. The proper care and maintenance that your vehicle requires are outlined in this manual. Following the instruction will ensure a long trouble-free operating life of this vehicle and your satisfaction with it.

The owner's manual corresponded to the latest state of this vehicle at the time of printing. Slight deviations resulting from continuing development and design can, however, not be completely excluded. All specifications are non-binding, we reserve the right to modify or delete technical specifications, parts, design, etc... without prior notice.

SAFETY WARNINGS

This vehicle is NOT A TOY and ONLY used in closed-off areas remote from public road traffic. Never permit children under age 14 to operate this vehicle.

Adult's supervision is required if children under age 16.

WARNING:

Riding this vehicle can be a hazardous activity. Certain conditions may cause the equipment to fail without the fault of the manufacturer. Like other vehicles, the Mini Dirt Bike can and is intended to move, and it is therefore possible to lose control, fall off and/or get into dangerous situations that no amount of care, instruction, or expertise can eliminate. If such things occur you can be seriously injured or die, even when using safety equipment and other precautions. **RIDE AT YOUR OWN RISK AND USE COMMON SENSE.**

This manual contains many warnings and cautions concerning the consequences of failing to maintain, inspect or properly use your mini dirt bike. Because any incident can result in serious injury or even death, we do not repeat the warning of possible serious injury or death each time such a possibility is mentioned.

APPROPRIATE RIDER USE AND PARENTAL SUPERVISION

This manual contains important safety information and useful tips to help you and your child operate and handle the mini dirt bike. Carefully read the manual in its entirety together with

ELECTRIC MINI MOTORCYCLE OWNER'S MANUAL

your child before letting your child ride it for the first time. The manual also contains important information on servicing the vehicle.

It is your responsibility to review the manual and make sure that all riders understand all warnings, cautions, instructions, and safety topics and assure that the riders are able to safely and responsibly use this product and protect your child from injury. We recommend that you periodically review and reinforce the information in this manual with your child, and that you inspect and maintain your children's vehicle to ensure their safety. The recommended rider age of 14 years is only an estimate and can be affected by the rider's size, weight, or skills. Any rider unable to fit comfortably on this vehicle should not attempt to ride it.

It is important and necessary to conduct technical training for your child before first use. To get the train information, please contact the dealer who you purchase the vehicle from. Before your child completes the training, do not let your child use this vehicle.

Children often underestimate or fail to recognize the dangerous situation, you should make it clear to your child that should not, under any circumstances, operate the vehicle without supervision and that your child may only drive at speeds that are commensurate with the child's riding ability and other road condition.

A parent's decision to allow his or her child to ride this vehicle should be based on the child's maturity, skill, and ability to follow rules.

Keep this product away from small children younger than age 14 and remember that this product is intended for use only by persons who are, at a minimum, completely comfortable and competent while operating the vehicle.

Do not exceed **90kgs** total weight on this vehicle. Rider weight does not necessarily mean a person's size is appropriate to fit or maintain control of this vehicle.

Do not touch the brakes or motor on your bike when in use as they can become very hot.

ACCEPTABLE RIDING PRACTICES AND CONDITIONS

Always check and obey any local laws or regulations which may affect the locations where the vehicle may be used.

Ride defensively. Watch out for potential objects that could catch your heel or force you to swerve suddenly or lose control. Be careful to avoid pedestrians, skaters, skateboards, scooters, bikes, children or animals who may enter your path, and respect the rights and property of others.

This vehicle is meant to be used only in controlled environments free of potential traffic hazards and not on public streets or sidewalks. Do not ride your vehicle in any areas where pedestrians or product traffic is present.

Do not activate the throttle (speed control) on the hand grip unless you are on the vehicle and in a safe, outdoor environment suitable for riding.

The vehicle was manufactured for performance and durability but was not impervious to damage. Jumping or other aggressive ridings can over-stress and damage any product, including this vehicle. The rider assumes all risks associated with the high-stress activity. Be careful and know your limitations. The risk of injury increases as the degree of riding difficulty increases. The rider assumes all risks associated with aggressive riding activities.

Maintain a hold on the handlebars at all times.

ELECTRIC MINI MOTORCYCLE OWNER'S MANUAL

Never carry passengers or allow more than one person at a time to ride the vehicle.

Never use near steps or swimming pools.

Keep your fingers and other body parts away from the drive chain, steering system, wheels, and all other moving components.

Never use headphones or a cell phone when riding.

Never hitch a ride with another vehicle.

Do not ride the vehicle in wet or icy weather and never immerse the vehicle in water. The electrical and drive components could be damaged by water or create other possibly unsafe conditions.

The vehicle is intended for use on flat, level ground without loose debris such as rocks or gravel. Wet, slick, bumpy, uneven or rough surfaces may impair traction and contribute to possible accidents. Do not ride the vehicle in mud, ice, puddles or water. Avoid excessive speed that can be associated with downhill rides. Never risk damaging surfaced such as a carpet or flooring by use of the vehicle indoors.

Do not ride at night or when visibility is limited.

PROPER RIDING ATTIRE

Always wear proper protective equipment such as an approved safety helmet, elbow pads, and kneepads. A helmet may be legally required by local law or regulation in your area. A long-sleeved shirt, long pants, and gloves are recommended. Always wear athletic shoes, never drive barefooted or in sandals, and keep shoelaces tied and out of the way of the wheels, motor, and drive system.

USING THE CHARGER

The charger supplier with the vehicle should be regularly examined for damage to the cord, plug, enclosure, and other parts, and in the event of any damage, the bike must not be charged until the charger has been repaired or replaced.

Use only with the recommended charger.

Use caution when charging.

The charger is not a toy. The charger should be operated by an adult.

Do not operate the charger near flammable materials.

Unplug charger and disconnect from bike when not in use.

Always disconnect from the charger prior to wiping down and cleaning the vehicle with liquid.

ELECTRIC MINI MOTORCYCLE OWNER'S MANUAL

FAILURE TO USE COMMON SENSE AND HEED THE ABOVE WARNINGS INCREASES RISK OF SERIOUS INJURY. USE WITH APPROPRIATE CAUTION AND SERIOUS ATTENTION TO SAFE OPERATION.

WARNING STICKER LOCATION

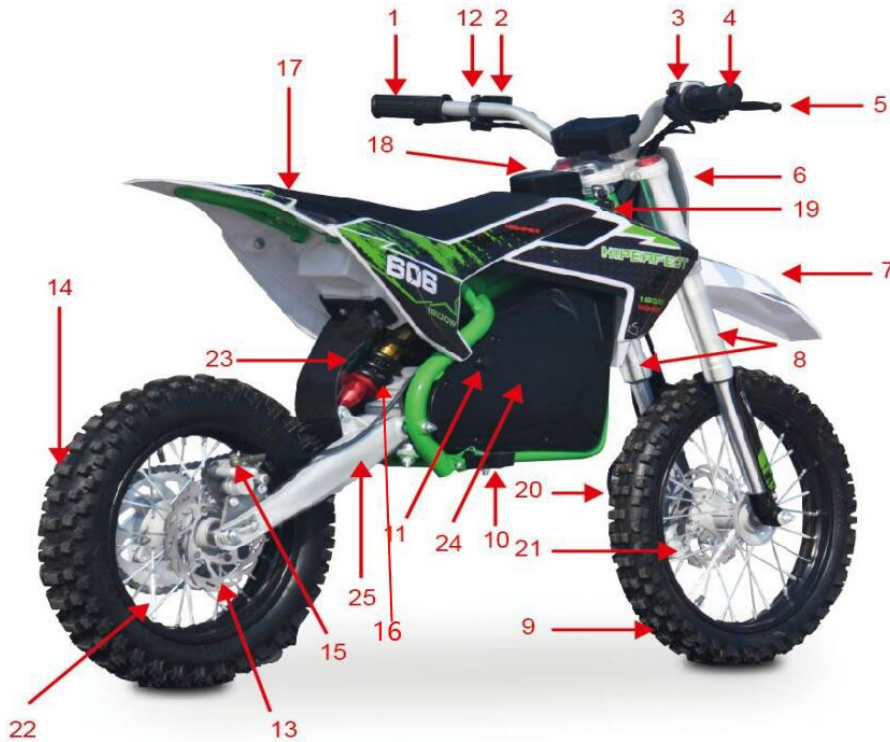

Sticker A is located on the left front suspension.

⚠ WARNING

Improper Vehicle use can result in SEVERE INJURY or DEATH.

			
ALWAYS USE AN APPROVED HELMET AND PROTECTIVE GEAR	NEVER USE ON PUBLIC ROADS	NEVER CARRY PASSENGERS	NEVER USE WITH DRUGS OR ALCOHOL

- Never permit over allowed speed.
- An adult supervision required always.
- Never permit children under age 14 to operate this Vehicle.
- Over loading can adversely affect vehicle handling.
- Operator use only. Passengers prohibited.
- This vehicle is designed and manufactured for OFF-ROAD use only.
- Operation on public streets, roads or highways is illegal.
- Always wear a helmet and other protective equipment.
- Do not operate this vehicle after consuming Alcohol or Drugs.
- Gasoline is flammable. Shut off engine, avoid sparks and open flame when refueling.
- Read owner's manual carefully before riding

ELECTRIC MINI MOTORCYCLE OWNER'S MANUAL

Sticker B is located on the fuel tank.



Sticker C is located on the fuel tank

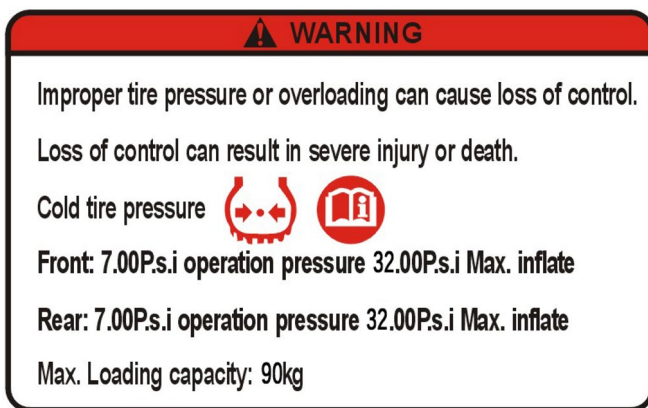

Sticker D is located in the chain cover.



Sticker E is located on the motor.



ELECTRIC MINI MOTORCYCLE OWNER'S MANUAL

Sticker F is located near the charging port.

⊘ WARNING ⊘

NOTE THE FOLLOWING

1. Adult supervision is required while charging.
2. There should be no flammable or explosive materials within 3 meters of the vehicle.
3. Please charge the vehicle after each use and then unplug once fully charged.
4. Charge every 1-3 months when not in use.
5. Only charge the vehicle with included charger.
6. Do not charge if the vehicle or charger gets wet.

PIN LOCATION



The PIN is stamp marked on an aluminum plate that is riveted on the rear swing arm.

There are the product main specification information on this PIN plate

PIN means the Product Identify Number which is unique for each unit.

ELECTRIC MINI MOTORCYCLE OWNER'S MANUAL

DIRT BIKE PARTS & FUNCTION



- | | | |
|-------------------------|-------------------------|------------------------------|
| 1. Handle bar left grip | 2. Handle bar | 3. Battery indicator |
| 4. Throttle | 5. Front brake lever | 6. Number board |
| 7. Front fender | 8. Front forks | 9. Front wheel |
| 10. Foot rest | 11. Charger port | 12. Rear brake lever |
| 13. Rear brake disc | 14. Rear wheel | 15. Rear brake caliper |
| 16. Rear shock | 17. Seat | 18. Speed adjustment cabinet |
| 19. Electric door lock | 20. Front brake caliper | 21. Front brake disc |
| 22. Chain | 23. Rear fender | 24. Battery/motor cover |
| 25. Rear swim arm | | |

BATTERY INDICATOR

Note: STOP using the bike and charge the battery once the indicator turns into red and yellow light only.

ELECTRIC MINI MOTORCYCLE OWNER'S MANUAL

FUNCTION SWITCH OF SPEED ADJUSTMENT

The speed adjustment cabinet is located in front of the seat.



There are two switch for the speed control as follows,

Switch 1: control the speed from min. to max.

Switch 2: control the starting accelerated speed

WARNING! Speed MUST be adjusted to suit the abilities of the rider. It is IMPERATIVE that the responsible adult controls speed setting. ALWAYS start the vehicle at the slowest speed . Never allow the child to alter speed settings.

BEFORE YOU BEGIN

Remove contents from box. Remove the foam separators that protect the components from damage during shipping. Inspect the contents of the box for scratches in the paint, dents or kinked cables that may occur during shipping. Because the product was 85 percent assembled and packed at the factory, there should not be any problems, even if the box has a few scars or dents.

MAKE SURE THE ON/OFF SWITCH IS TURNED “OFF” BEFORE CONDUCTING ANY PROCEDURES.

Estimated Assembly and Set-Up Time

We recommend assembly by an adult with experience in motorbike or bicycle mechanics.

Allow up to 30-40 minutes for assembly.

Allow up to 4-8 hours for initial charge.

Required Tools

Some tools may be supplied; however, we recommend the use of mechanic's grade tools. Use the supplied tools only as a last resort.

ELECTRIC MINI MOTORCYCLE OWNER'S MANUAL

Assembly illustration and instruction

ASSEMBLY HANDLEBAR

Caution: Failure to properly adjust and tighten the bolts that affix the handlebar can cause you lose control and crash.

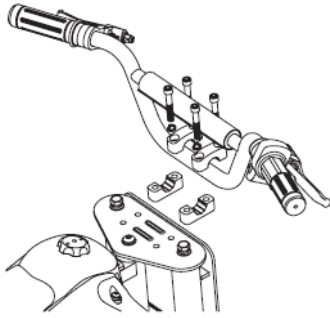

1 Place the handlebars in the handlebar clamps.

Note: Handlebar clamps are located in the plastic bag.

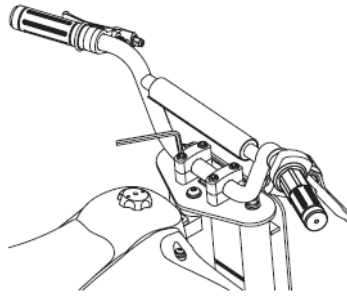

2 Align parallel to the fork and tighten the bolts using a 6mm L-wrench. When properly tightened, the handlebars should not move forward or back.

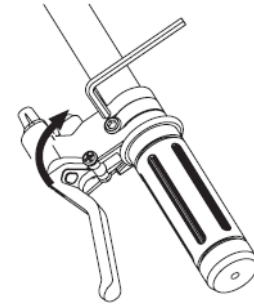

3 Adjust the brake lever adjuster to the proper place and tighten it with the 5mm key wrench.

ASSEMBLY FRONT WHEEL

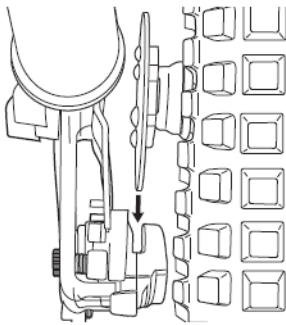

1 Position wheel in front fork and slide disk brake into caliper.

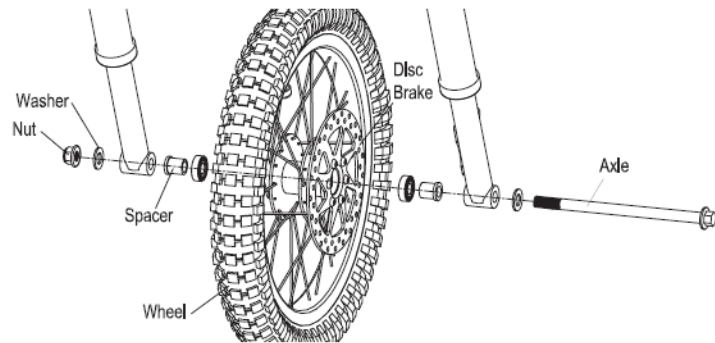

2 Slide axle through fork, spacer and wheel hub. When axle passes through the other side of the wheel hub, add the other spacer and slide through the fork. Secure with washer and nut.

Note: Front axle is installed with the spacer between the fork and wheel for all Dirt Rockets.

Note: If your model has one short spacer, it goes on the side of the hub with the disc brake.

ELECTRIC MINI MOTORCYCLE OWNER'S MANUAL

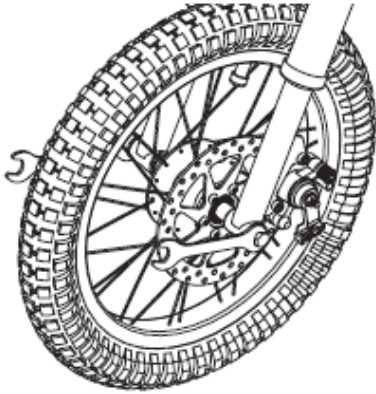

3 With a 14mm and 17mm wrench tighten the front wheel screws.

INFLATING THE TIRES

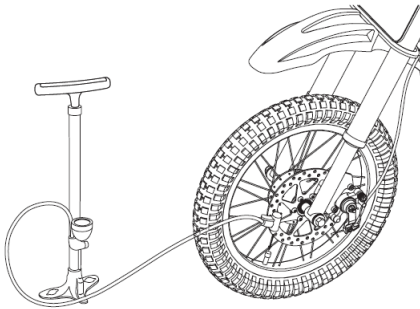

NOTE: The tires are inflated when shipped, but they invariably lose some pressure between the point of manufacturing and your purchase. Always inflate the tires to the correct PSI before first time use.

Please read the specification sheet to get the information of tire pressure.

Using a bicycle-style tire pump to inflate the tire to the PSI indicated on the sidewall of the tire.

Note: The pressurized air supplies found at gasoline stations are designed to inflate high-volume automobile tires. If you decide to use such an air supply to inflate your tires, first make sure the pressure gauge is working, then use very short bursts to inflate to the correct PSI. If you inadvertently over-inflate the tire, release the excess pressure immediately.

Important information of use guider for tire

Note: The tire is the only contact between the vehicle to the road, the safety of various driving activities depends on the small area of the tire where contact with the road. Therefore, it is very important to keep the tire in good condition at any time and use the correct size and standard tire to replace the old ones.

ELECTRIC MINI MOTORCYCLE OWNER'S MANUAL

Guide:

Tire assembly and disassembly

It is strongly recommended that the tire assembly and disassembly should be done by an authorized technician with the necessary skills.

Tire inflating pressure

It is very important to keep the tire at the proper pressure and check the tire pressure before use. The inflating should be done while the tire is cold.

Tire maintenance

Tire tread depth should be checked regularly. (Shallower tread means less grip of the tire). You must stop to use the vehicle if the tire is pierced, disassemble the tire and check it carefully. Tire maintenance should be done by an authorized technician. The tire should be replaced immediately when it is distorted or damaged.

Tire replacement

It is important to use the correct size and standard tire as per our specification (see details in technical specification sheet)

Don't use the used tire if you are not sure its previous service condition.

Tire aging

Tire aging is unavoidable even the tire is not ever used or just used a few times. Tire aging is mainly reflected in the cracked section on side of tire and tire tread, sometimes the tire is distorted as well. The used and aged tire should be checked and confirmed if it is ok to use again by an authorized technician.

ELECTRIC MINI MOTORCYCLE OWNER'S MANUAL

BEFORE RIDING

Charging the Battery

You shall use the charger which should match this bike (never use a charger from a different model). Before charging, you must turn the power switch to "OFF". Keep the charger in a dry and ventilative condition when it's working.

The charger is designed for indoor use only. Keep the charger away from water to avoid a short circuit. Don't even use it in a dampening, combustible or explosive environment. Do not remove the plug by pulling the cord, always grip the charging port by its metal body.

Firstly connect the output plug of the charger with the socket of the battery case properly, and then insert the input plug into the AC electrical outlet. And the charger indicator will light on, which means it's on charging.

When the light turns from Red to Green, it means the battery has been fully charged. Usually it will take about 4-6 hours to recharge the battery depend on different status. However, it's a good suggestion that it's be charged for additional 2 hours after the light turn to green if you have time (It is good for the service life of the battery).

Do not charge it for more than 10 hours to avoid overcharging and damaging the battery. After the light turns GREEN, the charger is in the state of trickle electric current and "fill slowly " and maintain the state. If you are going to be out for a long time, you should pull out the charger plug, especially in hot weather.

The charger will become warm during charging, so keep the charger away from any heat source. Please always keep the charger dry and clean. The electronics inside contain high voltage, so please don't disassemble the charger by yourself.

After charging, please pull the input plug out of the electrical outlet first, and then pull out the output connecting plug from the battery case. Do not let the charger be plugged into the battery or electrical outlet for a long time, which may damage the charger and cause a fire.

While charging, please keep it out of the reach of children. Do not put anything on top of the charger when use, and prevent any liquid, metal or metal fillings to permeate into the charger. You can also remove the battery from the bike and then charge it.

Do not touch any poles in the battery case with your hands when the battery is removed for charging. Also the charging connector poles cannot be touched with any metal or any other material that conducts electricity, otherwise it may cause a short circuit.

ELECTRIC MINI MOTORCYCLE OWNER'S MANUAL

If you don't ride your bike for a long time, the battery should be charged at least one time per month. This will ensure battery life. **DO NOT** use in the state of low battery capacity. Do not leave your battery in a fully discharge state for long periods of time. The battery will continue to self-discharge, resulting in damage.

Avoid any contact with water when charging your battery. If a plug or socket gets wet, dry it completely before using it.

When charging, if there is a peculiar smell or the temperature is extremely high, please stop charging immediately and send to the local distributor or to the Customer Service Center.

WARNING: rechargeable batteries are only to be charged under adult supervision. Always disconnect your electric motorbike from the charger before cleaning with liquid.

NOTE: Chargers have built-in over charge protection to prevent the battery from being over charged. Charger will get warm during using. This is normal for some charges and is no cause for concern. If your charge does not get warm during use, it does not mean that it is not working.

Be sure to properly align the groove on the charger input port with the corresponding socket on the vehicle and tighten threads; otherwise, no charging action will occur.



The charger port is located on the right battery/motor cover.

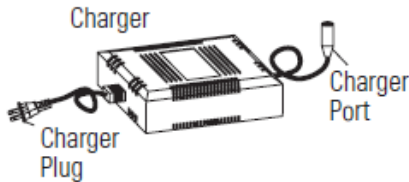

1 Turn **OFF** power switch before charging. Plug charger into the charger port on the electric motor bike.

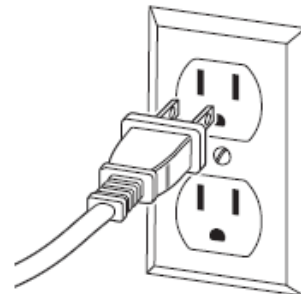

2 Plug the charger plug into a wall outlet. If the lights on the charger do not light up, check the power to the outlet. If necessary, try a different outlet.

ELECTRIC MINI MOTORCYCLE OWNER'S MANUAL

Warning: Failure to recharge the battery at least once a month may result in a battery that will no longer hold a charge.

SAFETY REMINDERS

PRE-RIDE CHECKLIST

Loose Parts

Check and secure all fasteners before every ride. Make sure steering stem clamp bolts are locked properly in place. There should not be any unusual rattles or sounds from loose parts or broken components. If you are not sure, ask an experienced mechanic to check.

Brake

Check the brake for proper function. When you squeeze the lever, the brake should provide positive braking action.

Frame, Fork and Handlebars

Check for cracks or broken connections. Although broken frames are rare, it is possible for an aggressive driver to bash into a curb or wall and wreck and bend or break a frame. Get in the habit of inspecting yours regularly.

Tire Inflation

Periodically inspect the tires for excess wear, and regularly check the tire pressure and re-inflate as necessary. If you get a flat tire, the inner tube can be patched or a new tube can be purchased from an authorized repair shop.

Safety Gear

Always wear proper protective equipment such as an approved safety helmet, elbow pads and kneepads. Always wear shoes (lace-up shoes with rubber soles), never drive barefooted or in sandals, and keep shoelaces tied and out of the way of the wheels, motor and drive system

ATTENTION

We recommend checking all tightened parts after the first time use. Special attention should be paid to the following parts:

- Footrest
- Shock absorber
- Engine bolts and nuts
- Rear sprocket
- Front & rear wheel bolts

REPAIR AND MAINTENANCE

Turn the power switch “OFF” before conducting any maintenance procedures.

Replacing The Fuse

1. Open the battery/motor cover to locate the fuse box attached to the batteries.
 2. Check the fuse to see if it has burnt out. If the fuse is damaged, open the fuse cover.

ELECTRIC MINI MOTORCYCLE OWNER'S MANUAL

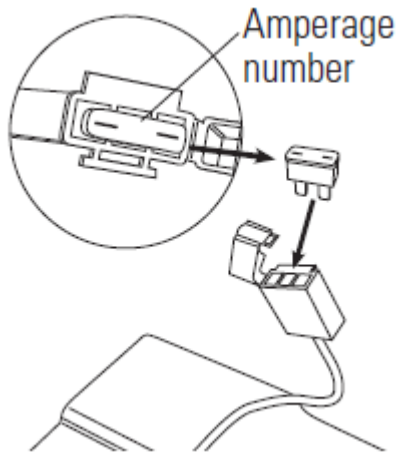

3. Remove any fuse that is damaged or burnt out and replace with a new one of equal amperage.

Note: Amperage is located on top of fuse.

WARNING:

To prevent shock, please follow above instructions accordingly and do not skip or combine any steps.

Checking Spoke Tension

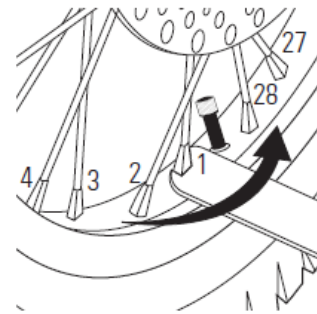
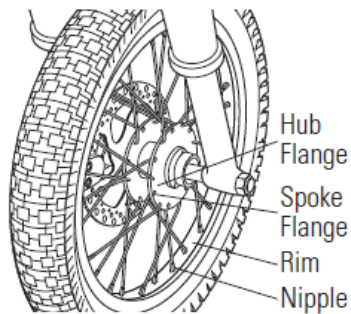
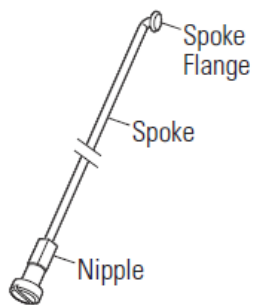

1 Verify the spoke tension by shaking each spoke with your fingers. Spoke should not be loose from hub. Look for any play between where the spoke flanges attach to the hub. Try to turn the nipple using your fingers. You should not be able to spin any nipple by hand. If one or more spokes is loose, all spokes must be checked and need to be tightened with a spoke wrench.

2 Start with spoke closest to the tire valve stem and tighten each nipple, in sequence, exactly 1/4 to 1/2 turn. A single 1/4 to 1/2 turn may not be enough to bring the spokes into proper tension. Continue tightening all spokes no more than 1/2 turn in sequence until all spokes are tight.

Note: More than a 1/2 turn each can cause the wheel to become distorted and wobbly thus permanently damaging the wheel.

ELECTRIC MINI MOTORCYCLE OWNER'S MANUAL

Testing the Brakes

To use the brake, squeeze the lever to increase the pressure on the brake. The brake lever is fitted with a cable adjuster to compensate for cable stretch and/or to fine-tune the lever movement to brake engagement. If brake is not engaging properly, follow instructions for adjusting the brakes.

Chain and sprocket

The chain will typically have a “loose spot” and “tight spot” corresponding with a particular sprocket rotational position. This is normal and common to all chain-driven products due to run-out to tolerance of the free wheel and sprocket. The chain should be adjusted to the ideal tension with chain in the tightest spot.

Proper chain alignment must be maintained. The wheel must not be skewed, if the chain is noisy or rough running, check the lubrication, tension and alignment of sprockets, in that order.

Warning:

To avoid a pinch or injury, keep fingers away from moving sprockets and chains.

Battery disposal



BATTERIES MUST BE RECYCLED.,

Disposal: Your product uses sealed lead-acid batteries or lithium battery which must be recycled or disposed of in an environmentally sound manner. Do not dispose in a fire. The battery may explode or leak. Do not dispose of the battery in your regular household trash.

Charger

The charger supplied with the bike should be regularly examined for damage to the cord, plug, enclosure and other parts, and, in the event of such damage, the bike must not be charged until it has been repaired or replaced.

USE ONLY WITH THE RECOMMENDED CHARGER

ELECTRIC MINI MOTORCYCLE OWNER'S MANUAL

TECHNICAL SPECIFICATION SHEET

Motor type	Brushless motor
Max.output	1600W 48V
Battery	48V14AH
Charger INPUT	100-240V/47-63 Hz/2.0A
Charger OUTPUT for 48V lithium battery	54.6V-2.0A
Charger OUTPUT for 60V lithium battery	67.2V-2.0A
Transmission	Chain drive
Front suspension	Hydraulic USD forks
Rear suspension	Hydraulic rear shock absorber
Tyre	FRONT: 60/100-14, REAR 80/100-12 with 7.00 P.s.i. operation pressure and 32 P.s.i Max. inflate .
Brake system	Front and rear hydraulic disc brake
Rated loading capacity	90KG
Vehicle size	1500*700*915MM

TRANSPORTATION

This vehicle should be transported in the normal position if possible. It may also be transported in the standing position, but the standing position is not as stable as the normal position.

PREPARATION FOR STORAGE

Some measures should be taken when the vehicle is subjected to a long term storage so as to reduce the bad influence on its performance. Before the storage, make necessary maintenance to ensure the vehicle high performance after-storage.

VEHICLE

Place the vehicle on level ground and thoroughly clean the entire vehicle. DO NOT get water into any part of the motor controller or battery.

Tighten all nuts, bolts, cap screws, and screws. Make sure rivets holding components together are tight. Replace all loose rivets. Care must be taken that all calibrated nuts, cap screws, and bolts are tightened to specifications.

Disconnect the battery cables (negative cable first); then remove the battery, clean the battery posts and cables, and store in a clean, dry area.

NOTE: For storage, use a battery maintainer or make sure the battery is fully charged.

TIRES

Inflate the tires to the normal specification.

EXTERNAL

Spray all vinyl and rubber parts with a rubber preservative.

Spray unpainted surfaces with rust preventative.

Coat painted surfaces with car wax.

ELECTRIC MINI MOTORCYCLE OWNER'S MANUAL

NOTE: Void storing outside in direct sunlight and avoid using a plastic cover as moisture will collect on the ATV causing rusting.

PREPARATION AFTER STORAGE

Clean the ATV thoroughly.

Check all control wires and cables for signs of wear or fraying. Replace if necessary.

Charge the battery, then install. Connect the battery cables making sure to connect the positive cable first.

Check the entire brake systems (fluid level, pads, etc.), all controls, headlights, taillight, brakelight; adjust or replace if necessary.

Check the tire pressure. Inflate to recommended pressure as necessary.

Tighten all nuts, bolts, cap screws, and screws making sure all calibrated nuts, cap screws, and bolts are tightened to specifications.

Make sure the steering moves freely and does not bind.

ELECTRIC MINI MOTORCYCLE OWNER'S MANUAL

TROUBLESHOOTING GUIDE

Problem	Possible cause	Solution
The vehicle does not run.	Undercharged battery. (The green light of the battery indicator is off.)	Charge the battery. A new battery should have been charged for 4-6 hours before using the vehicle.
		Check all connectors. Make sure the charger connector is tightly plugged into the charging port, and that the charger is plugged into the wall.
		Make sure the electric power to the wall outlet is on.
	The charger is not working.	You may check to see if your charger is working by using a voltmeter or asking the authorized service center to test your charger for you.
The vehicle was running but suddenly stopped.	Loose wires or connectors.	Check all wires and connectors to make sure they are tight.
	Burned-out fuse.	The fuse will burn out and automatically shut off the power if the motor is overloaded.
		An excessive overload could cause the motor to overheat. Refer to replacing the fuse instructions of this manual. Correct the conditions that caused the fuse to burn out and avoid repeatedly burning out the fuse.
Motor or electrical switch damage.	Contact the authorized service center for diagnosis and repair.	
Short run time less than 15 minutes per charge	Undercharged battery	Charge the battery. A new battery should have been charged for 4-6 hours before using the vehicle.
		Check all wires and connectors. Make sure the battery connector is tightly plugged into the charger connector, and that the charger is plugged into the wall.
		Make sure the power flow to the wall outlet is on.
	The battery is old and will not accept a full charge.	Even with proper care, a rechargeable battery does not last forever. The average battery life is 1 to 2 years depending on vehicle use and conditions. Replace only with a replacement battery.
	Brakes are not adjusted properly	Adjust the brake according to the instruction.

ELECTRIC MINI MOTORCYCLE OWNER'S MANUAL

The vehicle runs Sluggishly.	Driving conditions are too stressful.	Use only on solid, flat clean and dry surfaces such as pavement or level ground.
	Tires are not properly Inflated.	The tires are inflated when shipped, but They invariably will lose some pressure Between the point of manufacturing and your purchase. Refer to tire instructions to properly inflate tires.
	The vehicle is overloaded.	Make sure you do not overload the vehicle by allowing more than one rider at one time, exceeding the maximum weight limit, going up too steep a hill or towing objects behind the vehicle. If the vehicle is overheated, the temperature circuit protector will slow motor down and if the condition continues, will shut off power to the motor. Correct the driving conditions that caused the overheating, wait 5-10 minutes and then resume riding. Avoid repeatedly overheating the unit.
Sometimes the vehicle doesn't run, but other times it does.	Loose wires or connectors	Check all wires around the motors and all connectors to make sure they are tight.
	Motor or electrical Switch damage.	Contact the authorized service center for diagnosis and repair.
The charger gets warm During use	The normal response to Charger use	No action required. This is normal for some Chargers and is no cause for concern. If your charger dose not get warm during use, it does not mean that it is not working properly.
The vehicle does not Stop when applying the brake.	Brakes are not adjusted properly	Refer to brake instructions to properly adjust Brakes.
The vehicle makes loud noises or grinding sounds	The chain is too dry	Apply a lubricant to the chain.

CIRCUIT DIAGRAM

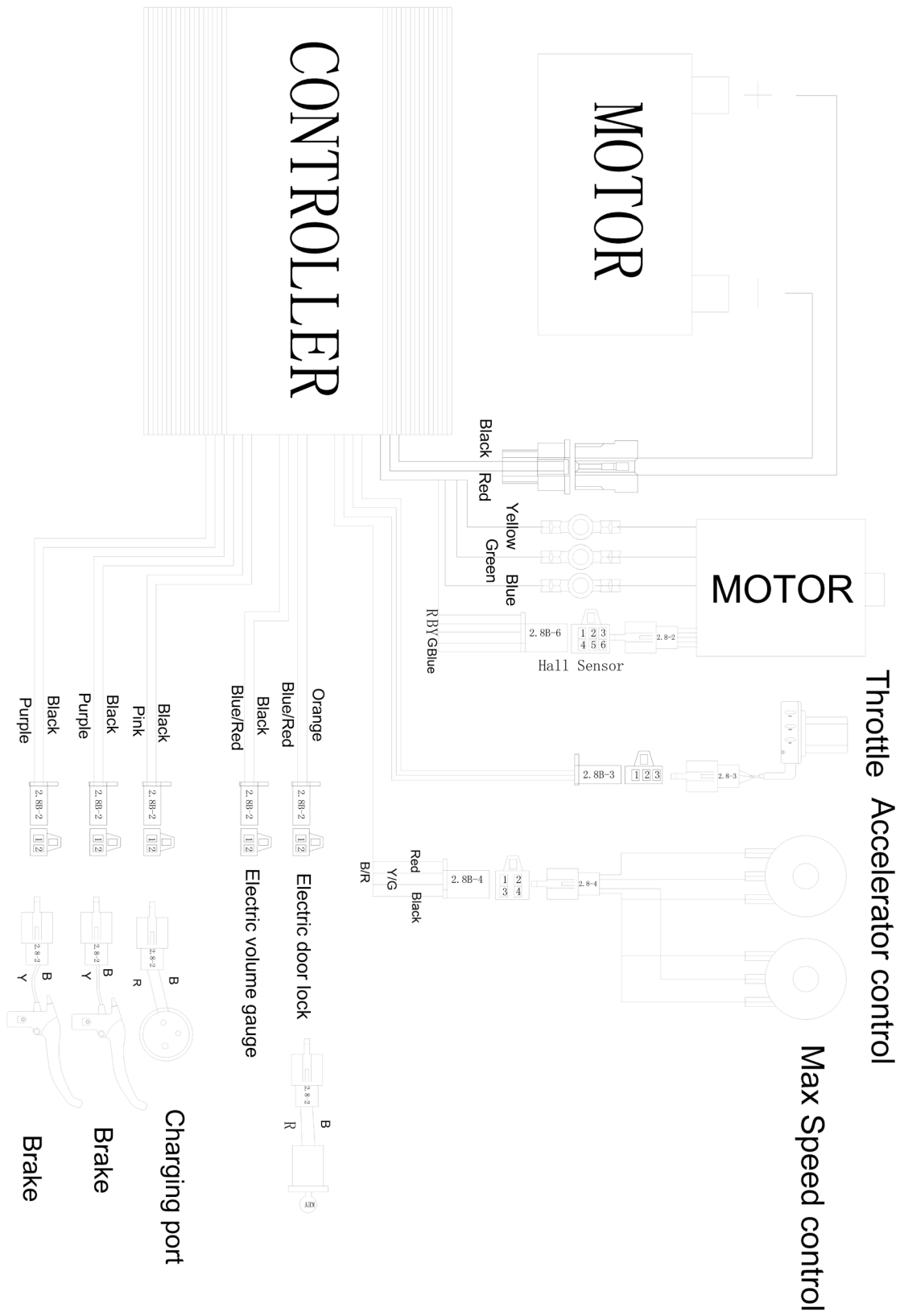

ELECTRIC MINI MOTORCYCLE OWNER'S MANUAL



Please read the owner's manual before riding.



Never use the vehicle on public road. OFF ROAD use only.



Never ride with a passenger



Always use an approved helmet and protective gear



NEVER use with drugs or alcohol



Cold tire pressure.



Never operate this vehicle if you are under age 14

NICROX

Nordbutiker AB
Gösvägen 28
76141 Norrtälje
+46 10-555 91 23
info@rull.se